

Data	
Float housing	PP Foam
Magnet	Ferrite Y10
Magnetical Orientation	axially

Remanence Br	mT	215
Coercivity HcB	kA/m	143
Coercivity HcJ	kA/m	203
Energy Product (BH) max.	kJ/m ³	8
Magnetic Moment M	x10 ⁻⁶ Vs cm	4.1
Operating Temperature max.	°C	80

Nominal values unless otherwise specified.

Dimensions in mm

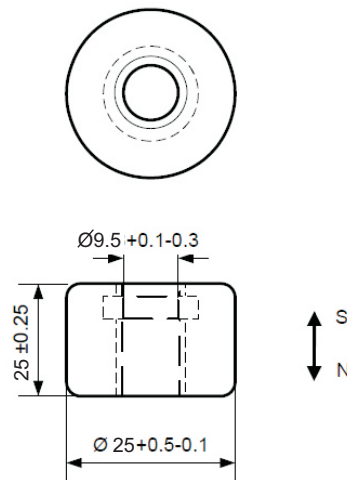

Customized types, other magnet materials and high temperature grades available

Mechanical Characteristics		@ 25°C
Density of float typ. *	g/cm ³	0.7
Weight per piece	g	3.86±0.3
* In delivery condition		
Operating pressure	mpa	1

As a result of our policy of continual improvement, the information in this document is subject to change without any notice and it is intended only as general guidance on product performance and suitability. This information shall not form part of any contract.

our product should be installed by a qualified personnel only, therefore any use of this application is at the installer's own risk and should be accessed appropriately.

HEM KUNT ELECTRONICS

Contact Details : Website- www.hemkuntelectronics.com
 EMail- hemkuntalert@gmail.com
 Address- 4583/13 Jai Mata Market, Tri Nagar, Delhi- 110035
 Telephone numbers- 011-27394466 ,+91-9810822092, +91-8800445952